

DAY FROM A <b>NO</b> 12:00 AM	<input type="button" value="↑"/> ON	<input type="button" value="↓"/> OFF	A B	MAIN START ADV.
----------------------------------	--	---	--------	-----------------------

<input type="button" value="OFF"/> <input type="button" value="AUTO"/>	
WATER BUDGET %	CUSTOM SCHEDULE
CURRENT TIME AND DAY MIN HR DAY	DAYS TO WATER MON TUE WED THU FRI SAT SUN
PROGRAM START TIMES 3 2 1	1 2 3
WATERING TIME PER STATION	

<b>RAIN BIRD</b> ESP-6TM	DAY CYCLE <input type="button" value="T"/> FIXED 2 3 5 CUSTOM
-----------------------------	---

# Installation, Programming, & Operation

ESP-4TM

ESP-6TM

ESP-8TM

# RAIN BIRD®

# Contents

<b>INTRODUCTION</b> .....	<b>1</b>
Quick Reference Guide .....	1
Controller Stations .....	2
Sample Station Layout .....	3
Controls and Switches .....	4

<b>PROGRAMMING THE CONTROLLER</b> .....	<b>5</b>
Default Program .....	5
Programming Checklist .....	6
Fill Out Program Schedule Sheet .....	7
Select Watering Schedule .....	10
Set Current Time .....	11
Set Current Day .....	12
Custom Schedule .....	12
Fixed Schedule .....	13
Select Program .....	14
Set Station Watering Days .....	15
Set Station Run Times .....	16
Set Watering Start Times .....	17

<b>OPERATING THE CONTROLLER</b> .....	<b>19</b>
Turn Controller On and Off .....	19
Adjust Water Budget Percent .....	21
Use Manual Start / Advance .....	23
Run Test Program .....	24

<b>REPLACING THE BATTERY</b> .....	<b>25</b>
------------------------------------	-----------

<b>INSTALLING THE CONTROLLER</b> .....	<b>26</b>
Select Location .....	26
Mount Controller .....	27
Connect Field Wiring .....	29
Station Valve Wiring .....	30
Master Valve Wiring .....	30
Pump Start Relay Wiring .....	31
Install Battery .....	32
Install Transformer .....	33
Install Wiring Skirt .....	34

<b>TROUBLESHOOTING</b> .....	<b>35</b>
------------------------------	-----------

**HAVE A QUESTION, PROBLEM, OR COMMENT?**

**Our toll-free Technical Services phone number is 1-800-247-3782**

# INTRODUCTION

Congratulations on purchasing a Rain Bird ESP-TM solid state controller. This manual describes how to install, operate, and maintain your controller. Please read these instructions carefully.

For your convenience, we have included a Quick Reference Guide below, so you can quickly find instructions for common tasks.

---

## Quick Reference Guide

- If you want to:**
- Change the time of day ..... page 11
  - Turn the controller off and on  
(for example, because of rain) ..... page 19
  - Adjust watering times for all stations (for  
example, during a hot or cool period) ..... page 21
  - Start the sprinkler system manually ..... page 23
  - Install a new battery ..... page 25
  - Troubleshoot a controller problem ..... page 35

## Controller Stations

The controller has several stations as shown in the illustration on the following page. Each station is connected to a remote control sprinkler valve.

The valve opens when it receives a signal from the controller, and the sprinklers connected to the valve turn on. When these sprinklers have run for their allotted time, the controller shuts off the valve and opens the next valve in sequence.

For example, the illustration shows that station 1 is currently watering.

When station 1 is finished, the controller will shut it off and start station 2.

In the same way, station 3 will begin watering when station 2 is finished.

# Sample Station Layout

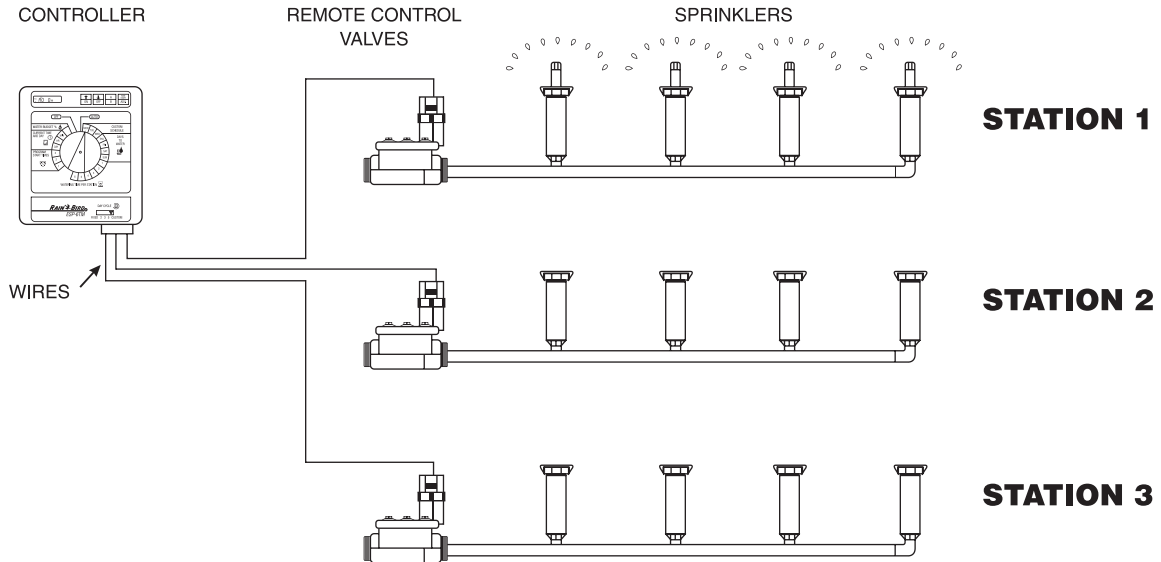

## Controls and switches

The illustration shows the programming controls on the face of the ESP-TM. These controls include:

- 1 LCD Display** - during normal operation, displays the time of day; during programming, shows the results of your commands; during watering, shows the station that is running and the minutes remaining in its run time.
- 2 Arrow ON-OFF Buttons** - used to set times and days, and to make program changes.
- 3 A / B Program Button** - used to select watering program A or B. (On some ESP models, this button is labeled PGM.)
- 4 Manual Start / Advance Button** - used to start the irrigation program manually or to manually advance watering from one station to the next.
- 5 Programming Dial** - used to turn controller off and on, and for programming.
- 6 Schedule Slide Switch** - used to select one of the fixed-interval watering schedules or a custom watering schedule.

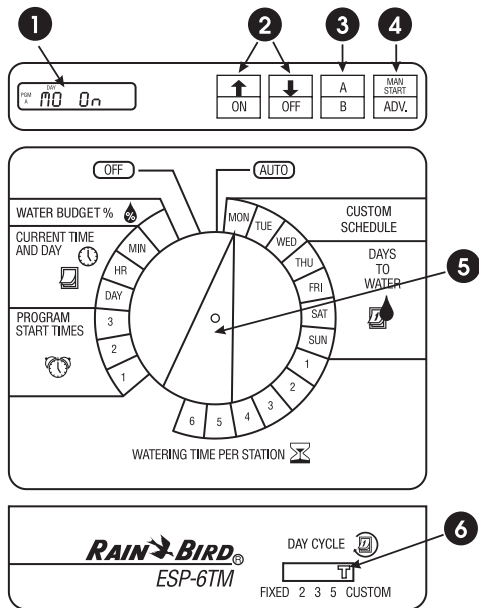

# **PROGRAMMING THE CONTROLLER**

Your ESP-TM controller is an electronic clock that controls when your sprinkler system turns on, and how long the sprinklers run.

Programming is the process of telling the controller exactly when and how long you want to water. The controller opens and closes the remote control valves according to the program you set.

- Each program contains: Watering days - the specific days of the week on which watering takes place (for example,

Monday, Wednesday, Friday), or the watering interval (for example, every third day).

- Start time - the time of day that the program begins; this is the time that the first station in the program begins watering; all other stations then follow in sequence.
- Run time - the number of minutes that each station runs.

---

## **Default Program**

The ESP-TM series controllers have a backup, or default, program that takes over if your program is lost because of an extended power outage.

When the default program is running, all stations revert to Program A, with 10 minutes of run time per station. The default starting time is 8:00 AM.

The default program will water every day if the Schedule Slide Switch is set to "Custom."

If the Schedule Slide Switch is set to one of the fixed intervals, the default program will run every two, three, or five days, depending on where the switch is set.

The Program A default settings will be in operation until you enter your desired settings for Program A. As you enter your settings in Program A, the default settings are pushed into reserve status as a backup program. If you are using only one of the two programs, make sure you use Program A.

# Programming Checklist

To program the ESP-TM controller for the first time, we recommend that you complete the following steps in order:

- Fill out Program Schedule Sheet ..... page 7
- Select watering schedule ..... page 10
- Set the current time ..... page 11
- Set the current day ..... page 12
- Select the program (A or B) ..... page 14
- Set station watering days (custom schedule only) ..... page 15
- Set station run times ..... page 16
- Set watering start times ..... page 17
- Set controller to automatic operation ..... page 19



# Fill Out Programming Chart

Before you begin programming, fill out the ESP-TM Controller Programming Chart and keep it for reference. A sample Programming Chart is shown in this illustration. Several blank Charts are provided for your use on the following pages.

- 1 Enter a brief description of each station on the controller.
- 2 In the Program A column, circle the Watering Days schedule. Either choose one of the "Fixed Day Cycle" intervals, or choose the desired watering days in the "Custom Day Cycle" row.
- 3 Enter the starting time(s) for Program A. You may have up to three separate start times for each program.
- 4 Enter the run time for each station assigned to Program A. Enter "0" for stations that are not used in Program A.
- 5 Repeat steps 2 - 4 for Program B. If you are using a fixed schedule, Program B will have the same watering days as Program A.

**RAIN BIRD**  
**ESP-TM Controller PROGRAMMING CHART**  
 Technical Services for U.S. and Canada only: 1-800-247-3782  
 www.rainbird.com

Watering Days  
 Program Start Times

Program A			Program B								
Fixed Day Cycle (applies to all programs)			2 Days	3 Days	5 Days						
Custom Day Cycle			Custom Day Cycle								
M	T	W	T	F	S	M	T	W	T	F	S
1	6:00	am pm	1	6:00	am pm						
2		am pm	2	4:30	am pm						
3		am pm	3		am pm						

Water Budget (applies to all programs) \_\_\_\_\_

Station	Description	Run Time	Run Time
1	front lawn rotors	25 min.	0
2	side lawn spray heads	8 min.	0
3	front flower bed	15 min.	0
4	back lawn rotors	0	20 min.
5	rose garden	0	7 min.
6			
7			
8			

Notes: \_\_\_\_\_ P/N 632989A



## ESP-TM Controller PROGRAMMING CHART

Technical Services for U.S. and Canada only: 1-800-247-3782  
www.rainbird.com



Watering  
Days



Program  
Start Times

Program A			Program B										
Fixed Day Cycle <small>(applies to all programs)</small>			2 Days	3 Days	5 Days								
Custom Day Cycle			Custom Day Cycle										
M	T	W	T	F	S	S	M	T	W	T	F	S	S
1	am	pm	1	am	pm	2	am	pm	3	am	pm		
Water Budget <small>(applies to all programs)</small>			.....										

Station	Description	Run Time		Run Time	
1					
2					
3					
4					
5					
6					
7					
8					
<b>Notes:</b>					P/N 632989A



## ESP-TM Controller PROGRAMMING CHART

Technical Services for U.S. and Canada only: 1-800-247-3782  
www.rainbird.com



Watering  
Days



Program  
Start Times

Program A			Program B										
Fixed Day Cycle <small>(applies to all programs)</small>			2 Days	3 Days	5 Days								
Custom Day Cycle			Custom Day Cycle										
M	T	W	T	F	S	S	M	T	W	T	F	S	S
1	am	pm	1	am	pm								
2	am	pm	2	am	pm								
3	am	pm	3	am	pm								
Water Budget <small>(applies to all programs)</small>			% .....										

Station	Description	Run Time		Run Time	
1					
2					
3					
4					
5					
6					
7					
8					

Notes: P/N 632989A

## Select Watering Schedule

The ESP-TM has two types of watering schedules, either fixed or custom. The fixed schedule sets watering to occur every second, third, or fifth day. The custom schedule lets you select specific days of the week on which watering is to occur.

The type of schedule you select applies to both programs, A and B. For example, you cannot set Program A to a fixed schedule and Program B to a custom schedule.

- 1 To use a fixed schedule, move the Schedule Slide Switch to one of the FIXED positions:

2 = every other day





3 = every third day

5 = every fifth day

- 2 To use the custom schedule, move the Schedule Slide Switch to the "CUSTOM" position.



## Set Current Time

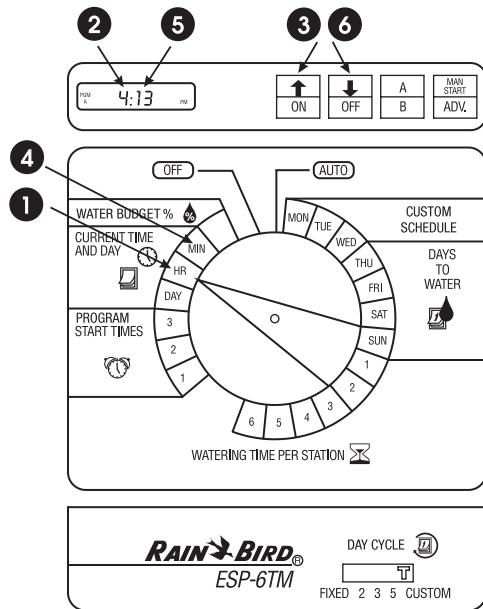

- 1 Turn the dial to "HR."
- 2 The display shows the hour that is currently set, either AM or PM.
- 3 Press  or  to set the current hour.
- 4 Turn the dial to "MIN."
- 5 The display shows the minute currently set.
- 6 Press  or  to set the current minute.



## Set Current Day



Setting the current day varies somewhat depending on whether you are using a custom schedule or a fixed schedule.

## Custom Schedule

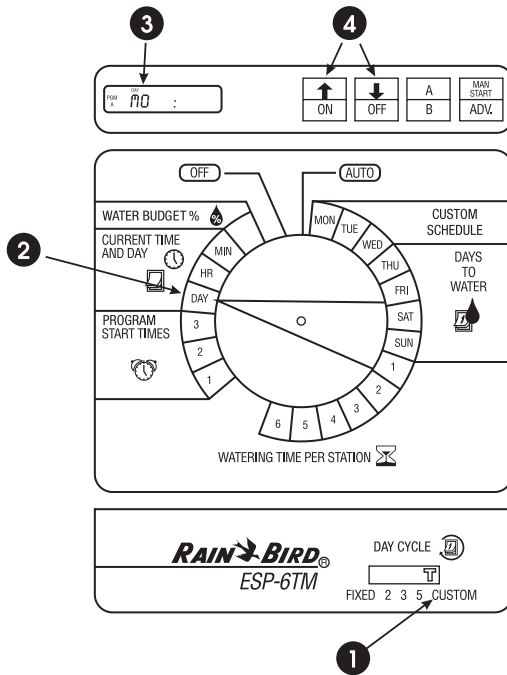
- 1 Make sure the Schedule Slide switch is set to "CUSTOM".
- 2 Turn the dial to "DAY."
- 3 The display shows the day of the week that is currently set (for example, "MO" for Monday).
- 4 Press  or  to change the display to the current day of the week.



## Fixed Schedule

- 1 Make sure the Schedule Slide switch is set to a fixed-day schedule: 2, 3, or 5.
- 2 Turn the dial to "DAY."
- 3 The display shows "1" for the first day of the watering cycle. Day 1 is always the watering day.
- 4 Press  or  to change the current day from 1.

If you want tomorrow to be the watering day, change the current day to the last day in your fixed schedule.

For example, if you're using a two-day schedule and you want to start watering tomorrow, set the current day to "2." If you're using a three-day schedule and you want to start tomorrow, set the current day to "3."

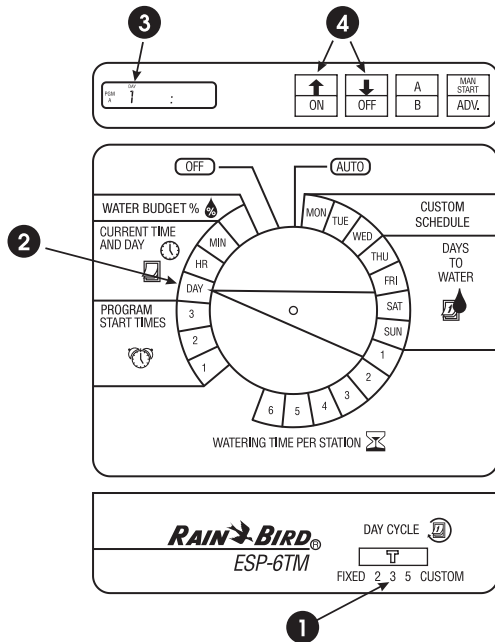

## Select Program

The ESP-TM controller has two programs, A and B. Each program operates independently.

If you are using the custom watering schedule, each program can have different watering days. For example, Program A might run on Monday, Wednesday, and Friday; Program B on Tuesday, Thursday, and Saturday.

If you are using a fixed watering schedule, both programs will have the same "ON" days. For example, if you are using the three-day fixed schedule, Program A and Program B will both run every third day.

You can assign any station to Program A, Program B, or both.

- 1 The program that is currently selected appears in the far left corner of the display. The display will show either "PGM A" or "PGM B."
- 2 To select the program, press the A / B (or PGM) button until the program you want appears in the display. Pressing the A / B button switches back and forth between the two programs.

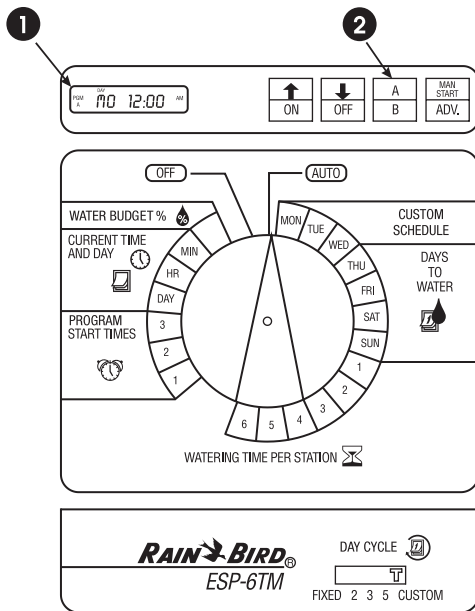



## Set Station Watering Days

**NOTE:** You must set station watering days **ONLY** if you are using the CUSTOM Schedule. If you are using one of the FIXED schedules, skip to page 16.

- 1 Turn the dial to "MON."
- 2 The display shows the day of the week (for example, "MO" for Monday) and either "ON" or "OFF." ON means the selected day is a watering day. OFF means watering doesn't take place on the selected day.
- 3 Press the ON or OFF button to set the selected day of the week on or off.
- 4 Turn the dial to the next day of the week. Repeat steps 2 and 3 until you have set each day of the week either on or off.

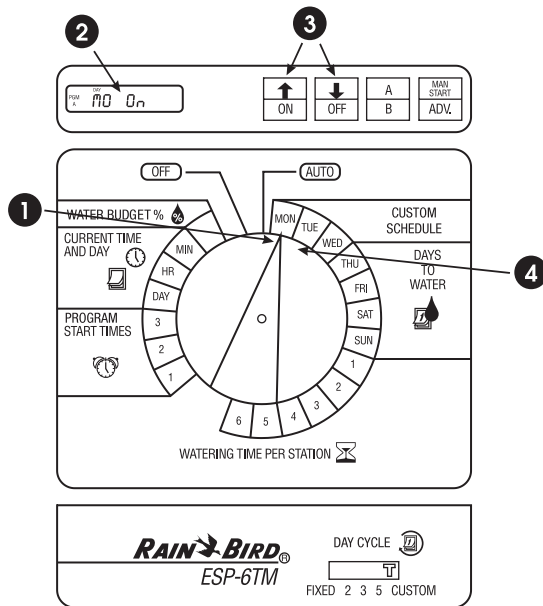

## Set Station Run Times

- 1 Turn the dial to Station 1.
- 2 The display shows the selected station and its run time. If you are programming the controller for the first time, or after a long power outage, the built-in run time of 10 minutes will appear.
- 3 Press  $\uparrow$  or  $\downarrow$  to change the display to the run time you want (up to 99 minutes). Set any unused stations to 0 minutes.
- 4 Turn the dial to the next station in sequence. Repeat steps 2 through 4 until you have set the run time for each station.

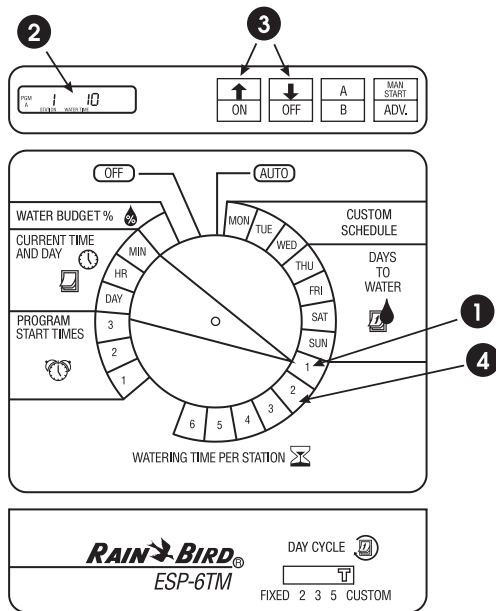

## Set Watering Start Times

Each program on the ESP-TM can have up to three watering start times, which tell the controller when to begin the watering program. The start time applies to all watering days for that program.

If you want to water more than once a day, you can set the second and third watering start times. For example, if you are growing new lawn seed, you might want to water several times a day. To do so, you could set a program to run at 6:00 AM, 11:00 AM, and 4:00 PM.

- 1 Make sure the program you want appears in the display. Either "PGM A" or "PGM B" will appear. To switch to the other program, press the A / B (or PGM) button.
- 2 Turn the dial to 1 in the "Watering Start Times" section.
- 3 The display shows the start time currently set for this program section.

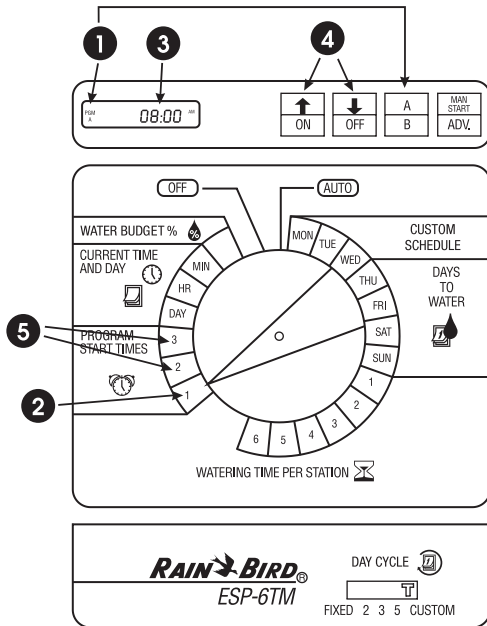

- 4 Press or to change the start time. The time setting moves forward or backward in 15-minute increments.
- 5 To eliminate a start time, press or until the blank setting between 11:45 PM and 12:00 AM appears.

If you want to set additional start times for this program, move the dial to 2 or 3 in the "Watering Start Times" section. Then repeat steps 3 and 4.

If you are following the programming checklist on page 6, you have now completed all programming steps for Program A. At this point, you may:

- Enter Program B by following the steps that begin on page 14, or
- Set the controller to automatic operation, as described on page 19.

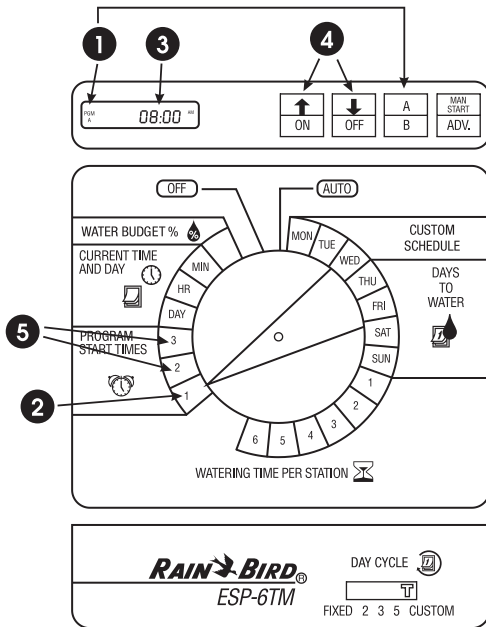

# OPERATING THE CONTROLLER

## Turn Controller On and Off

- ❶ To set the controller to automatic operation, turn the dial to AUTO. The display will show the current day and time until the next scheduled automatic start. When a program is running, the display will show the station currently turned on and the minutes remaining on its run time. When the entire program is complete, the display will change back to the current day and time.

If you forget to turn the dial to AUTO, the controller will eventually set itself to automatic operation. The only setting that prevents automatic operation is OFF (see step 2).

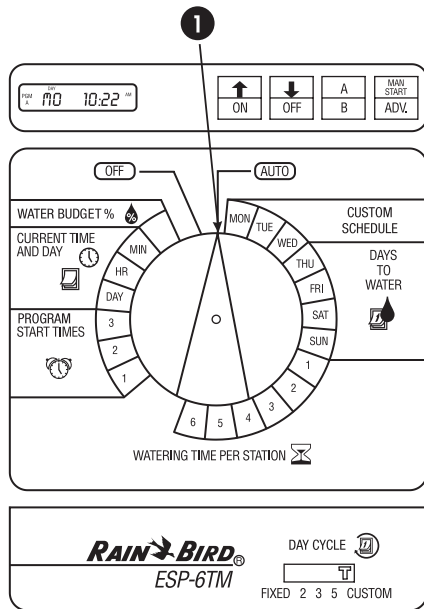

- 2 To turn the controller off and prevent all watering, set the dial to OFF. The display will show the current day and time. In addition, the right-hand minute digit will blink to show that the controller has been turned off.

The OFF setting can be used during rainy weather, seasonal shutdown, or system maintenance.

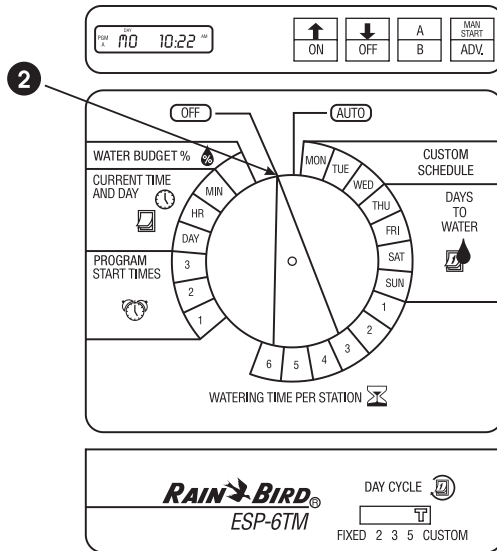



## Adjust Water Budget Percent

The Water Budget feature on the ESP-TM lets you increase or decrease the run times of all stations by a selected percentage. You may adjust the run times as low as 10 percent and as high as 200 percent. Adjustments must be made in increments of 10 percentage points.

The percentages are calculated on the normal programmed run times for each station. For example, if a station is programmed to run for 10 minutes, and you set the water budget percent to 80%, the station will run for 8 minutes (80% of 10 minutes). If you set the water budget percent to 120%, that same station will run for 12 minutes (120% of 10 minutes).

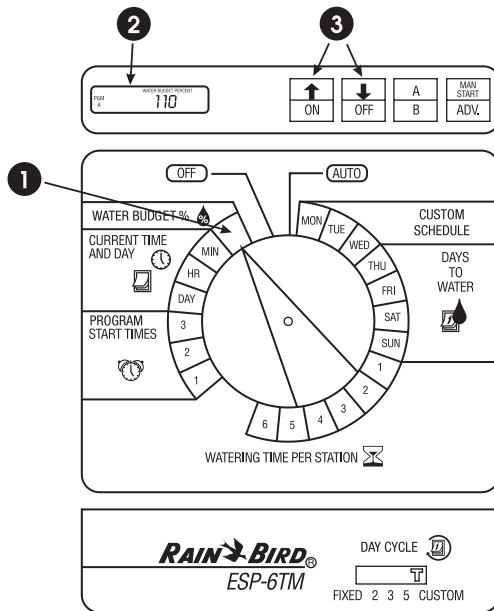
The water budget feature can be useful for cutting back watering during cool winter months, or for increasing watering during periods of unusual heat. Keep in mind that the percentage you set applies to **ALL** stations on **BOTH** programs.



- 1 Turn the dial to WATER BUDGET.
- 2 The display shows the current water budget setting (between 10% and 200%). A setting of 100% means that all stations will run according to their normal programmed run times.
- 3 Press  or  to increase or decrease the percentage in 10-point increments.

When water budgeting is set above or below 100 percent, the words WATER BUDGET PERCENT will appear in the top of the display.

To turn off water budgeting, repeat steps 1 to 3, and set the percentage to 100%.

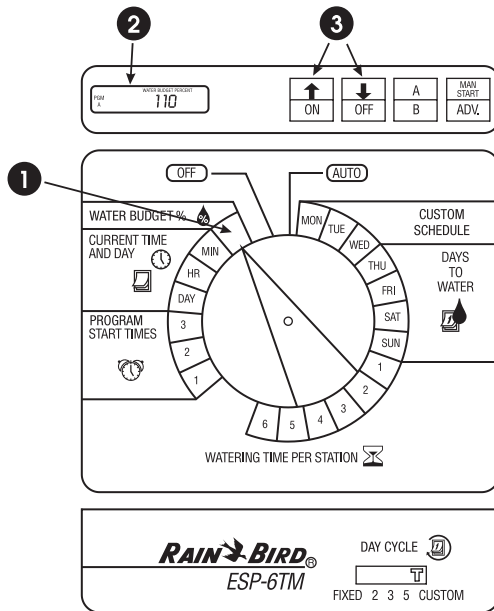



## Use Manual Start / Advance

- 1 Select the program you want to start. Press the A / B (or PGM) button to switch back and forth between the two programs.
- 2 Press the MAN START / ADV. button to begin the program with the first assigned station. To advance through the stations in the program, press MAN START / ADV. repeatedly until the station you want is displayed.

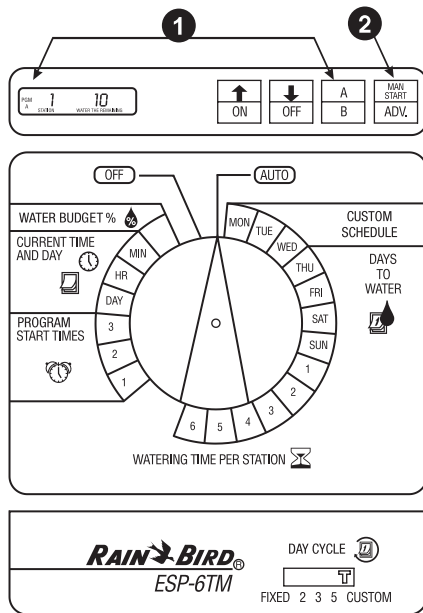

## Run Test Program

The ESP-TM has a built-in test program that will run stations with a scheduled run time in program A in sequence for two minutes. You can use this program to check out the operation of the sprinklers in the system.

- 1 Turn the dial to AUTO.
- 2 Press both arrow buttons at the same time and hold them down until...
- 3 The display shows the first station number and two minutes of watering time remaining. The controller will run each station with a scheduled run time in program A for two minutes, returning to AUTO mode to await the next scheduled start time. Any station that has been set to a 0 run time will be skipped during the test program.

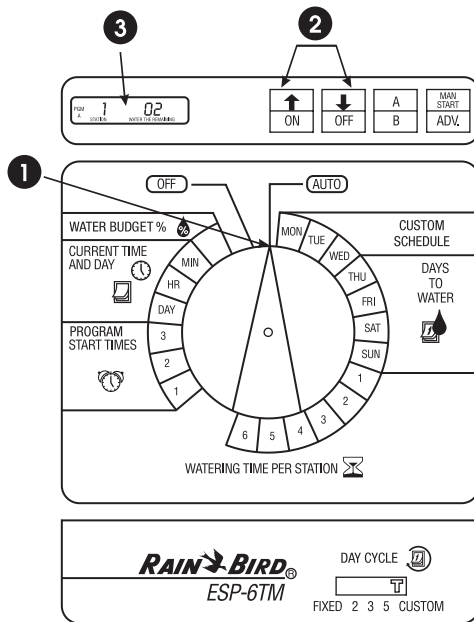

# REPLACING THE BATTERY

The ESP-TM controller features a battery backup, which will preserve the controller's program in the event of a power failure. Under normal conditions, the lithium battery will last well over a year. For maximum protection against loss of programming data, Rain Bird recommends that you replace the lithium coin cell battery once a year.

- 1 Remove the controller's lower face panel by gently prying out the panel at the slots on the left and right sides.
- 2 To replace the battery, pull out the battery drawer and remove the old battery. Install a new 3-Volt lithium coin cell battery in the drawer. Then close the drawer.
- 3 To install the face panel, align the rounded posts on the inside of the panel with the sleeves inside the cabinet. Also align the schedule slide switch with the internal switch on the circuit board. Then gently press the face panel until it clicks into place.

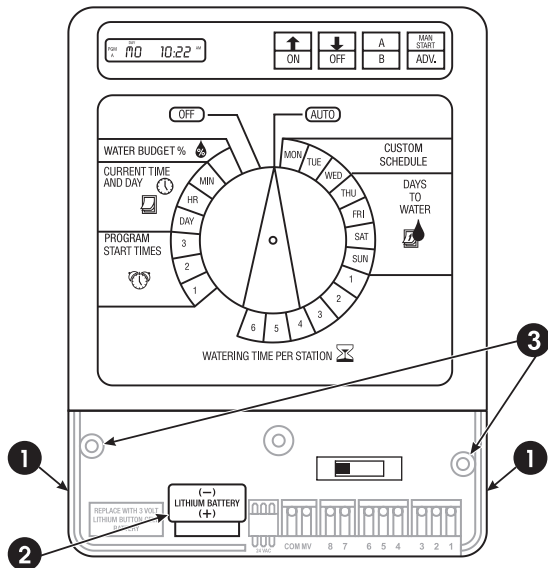

# ***INSTALLING THE CONTROLLER***

## **Select Location**

ESP-TM controllers are designed for indoor mounting only. For best results, mount the controller at eye level.

Mount the controller so that a 110-Volt AC power outlet is within five feet of the controller so the wires from the external transformer can be easily connected to the controller.

The ESP-TM controller has three "keyhole" slots on the back of the cabinet. Use these slots to mount the controller to a flat wall or vertical stud. Always use lower mounting hole "D" to secure the bottom of the controller.

## Mount Controller

- 1 Place the supplied mounting template in the desired location on the wall. Mark the screw center locations by punching through the template with a sharp tool.
- 2 Remove the template. Two plastic spacers are provided for the upper mounting screws only. (See illustration on the next page.)

Slip the spacers over the screws and drive them into the wall or stud at the upper keyhole marks: holes A and C for flat surfaces, or hole B only for an exposed stud.

When the wide, flat end of the spacer is pressed against the wall or stud, the screw is at the proper depth. Do **NOT** drive a fastener into location D at this time.

- 3 Remove the controller's lower face panel by gently prying out the panel at the slots on the left and right sides.
- 4 Hang the controller on the upper keyhole slots. Make sure the spacers are in the upper, narrow portion of the slots. Then drive a fastener through lower mounting hole D. The controller should now be secure.

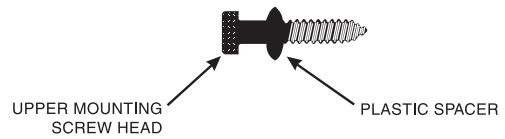
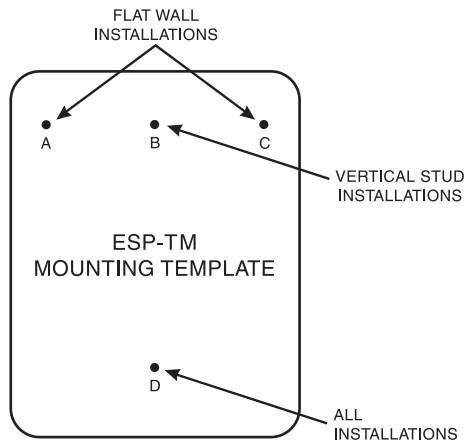
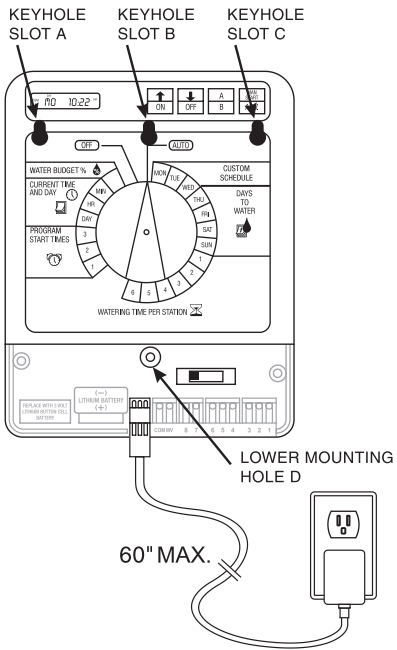

## Connect Field Wiring

The "flip strip" connector, shown in this illustration, allows fast and easy connection of field wires.

- 1 Wires connected to the flip strip should be stripped to expose 1/2" of conductor at the end. Do **NOT** use wires larger than 16 gauge. Wires smaller than 18 gauge should be doubled over before being inserted into the flip strip.
- 2 To connect field wires, raise the flip strip lever to the open position. Insert the stripped wire into the round hole beneath the lever. Then lower the flip strip lever to grip the wire.
- 3 Tug gently on each wire to make sure it's securely connected.

## Flip Strip (Bottom View)

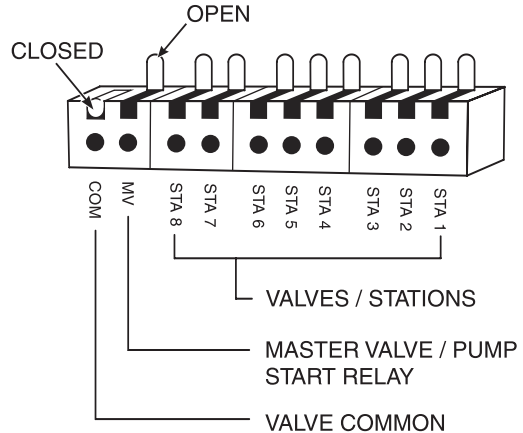

## Station Valve Wiring

Connect each valve by its own separate power wire to one of the numbered terminals on the ESP-TM flip strip, as shown in the illustration.

Connect a common wire to one of the leads on each valve. Connect the other end of the common wire to the COM terminal on the flip strip. Wire used to connect the valves must be code-approved for underground installation.

## Master Valve Wiring

**NOTE:** Complete this section **ONLY** if your system requires a master valve (an automatic valve installed on the mainline pipe upstream from the station valves).

Connect the master valve wiring to the MV terminal and COM terminal as shown in the illustration.

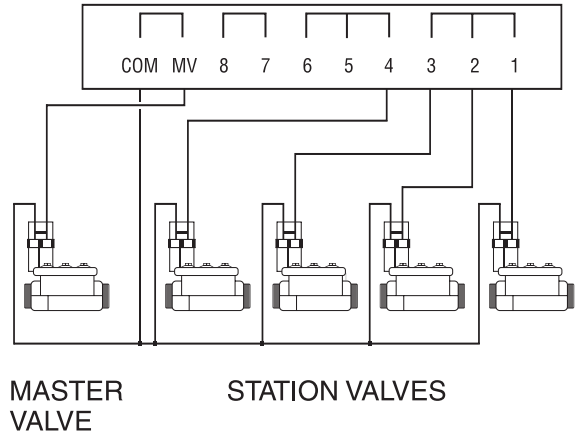



## Pump Start Relay Wiring

**NOTE:** Complete this section ONLY if your system requires a pump start relay.

The MV terminal on the flip strip can be used to connect a pump start relay. Connect one lead of the 24VAC pump start relay to the MV terminal and the other lead to the common wire, as shown in the illustration.

**CAUTION:** To prevent pump damage when using a pump start relay, use a jumper to connect unused stations to a station that is being used. If program information is lost during a prolonged power outage, the ESP-TM will automatically run a "default" program when power is restored. This program runs all stations for 10 minutes. If unused stations are not jumpered, the pump will operate with no flow (dead-head) during this 10-minute period. Dead-heading may cause the pump to overheat or burn out.

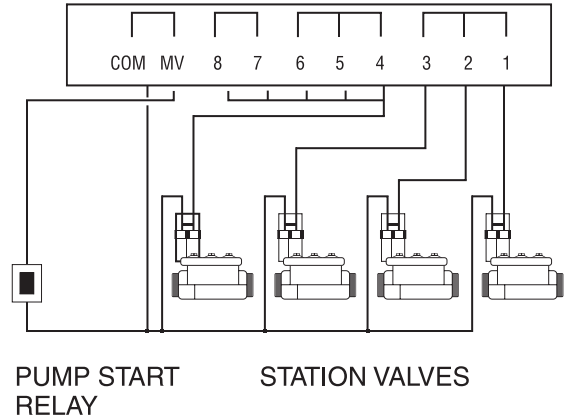

## Install Battery

The ESP-TM controller is factory-supplied with a 3-Volt lithium coin cell backup battery, which is wrapped in a protective insulator strip in the battery drawer. This battery is designed to maintain program information for several days without power.

If electrical power to the ESP-TM remains uninterrupted, the lithium coin cell will last well over one year. However, long or frequent power interruptions will use up the battery much faster.

To activate this battery, remove the lower face panel on the controller and remove the plastic insulator strip from the battery.

Make sure battery drawer is completely closed, then reinstall the lower face panel. See page 25 for complete instructions.

To install the face panel, align the rounded posts on the inside of the panel with the sleeves inside the cabinet. Also align the schedule slide switch with the internal switch on the circuit board. Then gently press the face panel until it clicks into place.

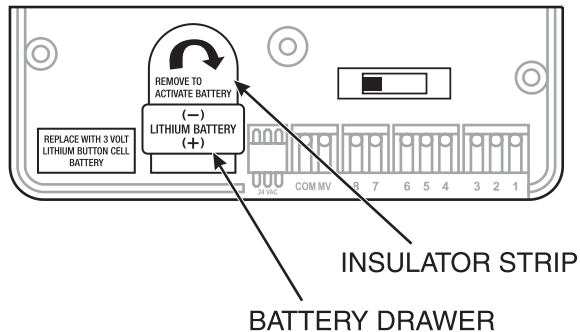

## Install Transformer

**CAUTION: DO NOT** plug the external transformer into an electrical outlet until all other connections have been made. In addition, connect the wires from the transformer to the ESP-TM flip strip BEFORE plugging in the transformer.

- 1 Connect the transformer connector to the 24 VAC power pin connection on the controller.

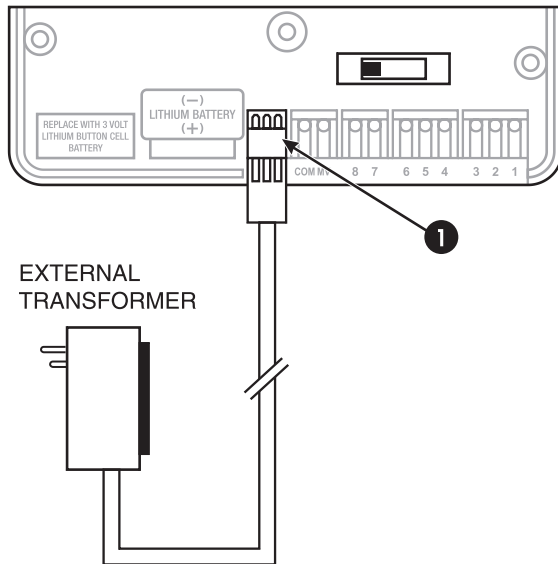

## Install Wiring Skirt

- 1 Slide the wiring skirt into its slot beneath the flip strip connector.
- 2 If you've used 3/4" PVC conduit to route the field wiring, you can route the transformer wires out of the side of the skirt by breaking out a small notch in the skirt with a pair of needle-nose pliers. See the illustration.
- 3 Secure the wiring skirt to the wall with two of the screws provided.
- 4 Snap the lower controller cover back into position.
- 5 Plug the 24VAC external transformer into a 110V outlet.

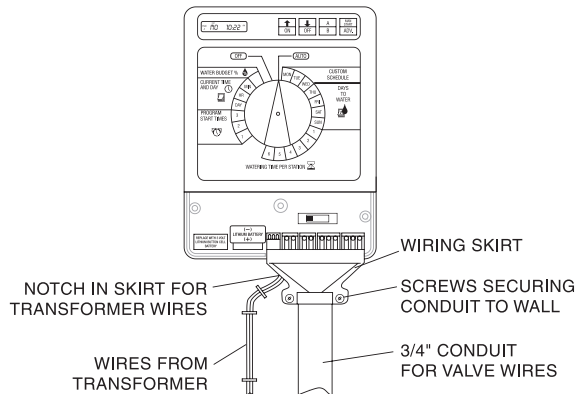

ESP-TM installation is now complete. Please refer to the programming instructions on page 5.



# TROUBLESHOOTING

NOTE: The ESP-TM has been updated and no longer has a fuse. The controller now operates with a Positive Temperature Coefficient (PTC), which is more robust than a fuse and acts as a resistor. Fuse replacement is no longer necessary.

<b>SYMPTOM</b>	<b>CAUSE</b>	<b>CORRECTION</b>
Display shows "PR OFF."	1. Power is off to the controller.	Determine why power to the controller has been interrupted, and re-establish power.  Unplug the controller and remove the battery. Wait two minutes. Then re-install the battery, and plug the unit in. Reprogram the controller.
Display is blank:	2. If the controller is still receiving power, an electrical surge exceeding the controller's built-in surge protection may have damaged the controller's microprocessor.	Unplug the controller and remove the battery. Wait two minutes. Then re-install the battery, and plug the unit in. If numbers and letters return to the display, the power surge did not do permanent damage. Reprogram the controller.  If the display remains blank, the ESP-TM may be permanently damaged. Call Rain Bird Technical Services at 1-800-247-3782 for a service referral.
	3. Power is off to the ESP-TM and the backup battery has run down.	Re-establish power to the controller, and then reprogram it. Replace the battery with a 3-Volt lithium coin cell.

<b>SYMPTOM</b>	<b>CAUSE</b>	<b>CORRECTION</b>
Display is scrambled, or shows numbers and letters, but is not moving or advancing.	Same as Cause #2.	See correction for Cause #2.
Schedule Slide Switch does not move.	4. Lower face plate cover is misaligned over the switch.	Remove the lower face plate cover by gently prying it out along the slots on the outside right and left edges. Reinstall the cover, making sure that the Schedule Slide Switch engages the black switch on the cabinet interior.
Valve does not come on	<p>5. No run time has been set for the valve</p> <p>6. A short circuit in the solenoid or valve wiring has disabled the station.</p> <p>Note: "Er M" will be shown in the display as  </p>	<p>Turn the dial to the valve number, and set the program switch to check the run time for the valve in each program.</p> <p>The display will show "Err #" where # is the valve number at fault. Identify and repair the fault in the circuit. If "Er M" occurs, repair the fault at the Master Valve. With the dial in AUTO, press the OFF button to clear the error message.</p>



**Rain Bird Corporation**

6991 E. Southpoint Road  
Tucson, AZ 85706, U.S.A.  
Phone: (520) 741-6100  
Fax: (520) 741-6522

**Technical Service and Support**

(800) RAINBIRD (U.S. & Canada only)

**Rain Bird Corporation**

970 W. Sierra Madre Avenue  
Azusa, CA 91702, U.S.A.  
Phone: (626) 812-3400  
Fax: (626) 812-3411

**Specification Hotline**

(800) 458-3005 (U.S. & Canada only)

**Rain Bird International, Inc.**

P.O. Box 37  
Glendora, CA 91740-0037, U.S.A.  
Phone: (626) 963-9311  
Fax: (626) 852-7343

**[www.rainbird.com](http://www.rainbird.com)**

The Intelligent Use of Water™-- Visit [www.rainbird.com](http://www.rainbird.com) to learn about our efforts

® Registered trademark of Rain Bird Corporation  
© 2008 Rain Bird Corporation